

Assessment of a Phase Doppler Anemometry Technique in Dense Droplet Laden Jet

Ja-Ye Koo*

*School of Aerospace and Mechanical Engineering, Hankuk Aviation University,
200-1 Hwajeon-dong, Duckyang-gu, Koyang-shi, Kyungki-do 412-791, Korea*

Jong-Hyun Kim

*Department of Automotive Engineering, Kyungwon college
Bokjung-dong, Songnam-shi, Kyungki-do 461-701, Korea*

This study represents an assessment of the phase-Doppler technique to the measurements of dense droplet laden jet. High-pressure injection fuel sprays have been investigated to evaluate the use of the Phase-Doppler anemometry (PDA) technique. The critical issue is the stability of the phase-Doppler anemometry technique for dense droplet laden jet such as Diesel fuel spray in order to insure the results from the drop size and velocity measurements are repeatable, consistent, and physically realistic because the validation rate of experimental data is very low due to the thick optical density. The effect of shift frequency is minor, however, the photomultiplier tube (PMT) voltage setting is very sensitive to the data acquisition and noise in dense droplet laden jet. The optimum PMT voltage and shift frequency should be chosen so that the data such as volume flux and drop diameter do not change rapidly.

Key Words : Phase-Doppler Anemometry (PDA), Dense Droplet Laden Jet, Validation Rate

1. Introduction

Fuel spray combustion is the prime energy source of liquid-fueled combustion devices such as Diesel engines, gas turbine, and liquid propellant rocket engines. The distribution of fuel in the combustion chamber at the start of combustion is critical to the subsequent mixture formation, ignition characteristics, and combustion rate, consequently to the engine efficiency and pollutant emissions. The distribution of fuel in the combustion chamber is controlled by the atomization process, mixing process, and vaporization process (Heywood, 1988 ; Borman, 1998).

Due to the importance of fuel distribution in the combustion chamber, many studies have been done experimentally and theoretically. Most of the experiments have been carried out in the far-downstream region of the spray, in steady or non-engine-like conditions. The major problem in the near nozzle region is obscuration due to the high droplet number density. A few experiments have been carried out near-nozzle region of the spray under unsteady (Yule and Aval, 1989) or close to engine-like conditions (Yule et al., 1985 ; Piltcher et al., 1990 ; Borman, 1985). However, there is a strong need for the characterization of the near-nozzle region of the spray and detailed information about droplet size and velocity distributions of the dense spray region. For this purpose, the phase-Doppler Anemometry (PDA) was used in the measurements of droplet size and velocity distributions in the dense region of the Diesel fuel spray. The difficulties and problems encountered in taking data using the PDA are described. In addition, the method used to apply

* Corresponding Author,

E-mail : jykoo@hau.ac.kr

● TEL : +82-2-300-0116; FAX : +82-2-3158-2191

School of Aerospace and Mechanical Engineering,
Hankuk Aviation University, 200-1 Hwajeon-dong,
Duckyang-gu, Koyang-shi, Kyungki-do 412-791,
Korea. (Manuscript Received December 6, 2002;
Revised April 4, 2003)

the PDA to dense fuel sprays and sensitivity to the instrument operational parameters such as PMT voltage and frequency shift are described.

2. Experimental Apparatus and Procedure

2.1 Experimental apparatus

The schematic diagram of experimental apparatus for the measurement of droplet sizes and velocities are shown in Fig. 1. The experimental apparatus consisted of an optical spray chamber (suitable for gas pressures up to 4.5 MPa), an electric motor driven pump injector system, and phase-Doppler anemometry. The sprays are very dense since they are formed from single-hole of diameter 0.24 mm or 0.41 mm. The nozzle L/d were 3.3 and 1.95, respectively. Five different ambient gas pressure conditions have been investigated, producing the range of gas to liquid density ratios. This span covers the range from injection into near-vacuum conditions, which should allow for the study of the spray in the absence of aerodynamic interactions, to conditions which duplicate the ρ_g/ρ_l found in diesel engines at the time of ignition (ρ_g : ambient gas density, ρ_l : spray liquid density). All tests were carried out with the gas and liquid isothermal at room temperature.

The primary diagnostic used in this study for the measurement of droplet sizes and velocities is an Aerometrics Phase-Doppler Anemometry. Figure 2 is the optical diagram of PDA. The PDA is an extension of the classical dual-beam Laser Doppler Velocimeter (LDV) with three detectors in the receiving optics for the determination of droplet or particle diameter. There are two pairs of detectors which give independent information about size. Durst and Zare (1975) proposed the idea that the phase difference between two Doppler signals collected at two position in space is proportional to the droplet size (dependent on the curvature of the scattering particle) and detector spacing. When a particle passes through intersection region of the two laser beams, an interference fringe pattern is formed by the scattered light. When the particle is moving, the

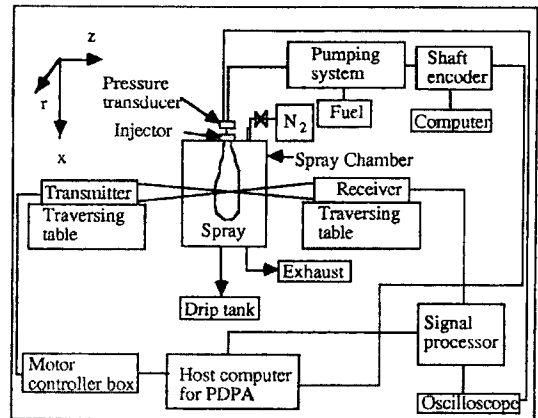

Fig. 1 Schematic diagram of experimental apparatus

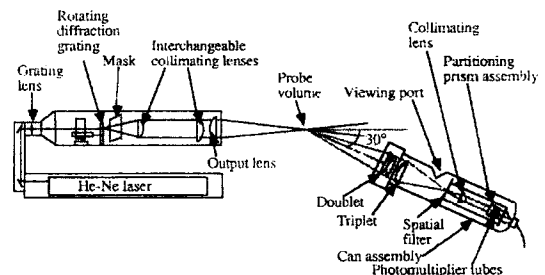

Fig. 2 Optical diagram of phase doppler particle analyzer

interference fringe pattern appears to move at the Doppler difference frequency. Particle size and velocity can be deduced from this interference fringe pattern. Droplet velocity is associated with temporal frequency of the scattered fringe pattern.

$$\text{velocity} = \delta \times f_D \quad (1)$$

where f_D is Doppler frequency and δ is static fringe spacing, giving

$$\delta = \frac{\lambda}{2 \sin(\gamma/2)} \quad (2)$$

where λ is wavelength of the light and γ is the beam intersection angle.

Droplet Diameter, D , is associated with the spatial frequency of the scattered fringe pattern projected to the detectors. Geometrical optical methods, which hold for $\pi D/4$ greater than 10, were used for the development of the theory of the PDA.

$$D = f(\lambda, n, f_s) \quad (3)$$

where λ is wavelength of incident light, n is refractive index of droplet, and f_s is spatial frequency. Two rays which have different optical paths enter the sphere at different angles and reach a point P in the receiver. The relative phase difference between ray 1 and ray 2 from beam 1 and beam 2 is

$$\begin{aligned} \phi &= \Delta_1 - \Delta_2 \\ \phi &= \frac{2\pi D}{\lambda} [(\sin \tau_1 - \sin \tau_2) - pm(\sin \tau_1 - \sin \tau_2)] \quad (4) \end{aligned}$$

where the angles τ are fixed by the receiver geometry. For a given light source, liquid fuel, and geometrical configuration of optics, the phase shift, ϕ is linearly proportional to the droplet diameter D .

The spatial frequency of the scattered fringe pattern is proportional to the droplet diameter. The spacing between scattered fringes is inversely proportional to the droplet diameter and also depends on where the observation is made. Phase shift can be measured using two detectors separated by known fixed spacing. The phase shift between detector i and j can be obtained from the following relation.

$$\phi_{i-j} = \frac{\tau_{i-j}}{\tau_D} \times (360^\circ) \quad (5)$$

where τ_{i-j} is the time between the zero crossings of the signals from detectors i and j , τ_D is the measured Doppler period.

The instrument has been tested for the validity of its application to sprays (Switzer and Jackson, 1988; Dodge et al., 1987). In other words, this instrument has been demonstrated to accurately provide fundamental data in relatively non-dense sprays. Dense sprays, such as the one investigated here, require much care in the use of the instrument. Because of practical limitations of the instrument and the complex nature and density of these sprays, it is unlikely that the accurate measurement of flux quantities can be accomplished. However, statistical quantities, such as the Sauter Mean Diameter (D_{32}), are very likely representative of the spray, if the instrument is used correctly.

2.2 Experimental procedures

The transmitter and receiver were mounted separately on three-dimensional traversing tables. The spray chamber was fixed in space. Before taking data, the level of the spray chamber, transmitter, and receiver were adjusted such that the spray axis (x-axis) was perpendicular to the plane of the optical bed. The x-axis is coincident with the central axis of the injector and r is perpendicular to central axis of the transmitter. All the data to be reported were obtained with the measurement position fixed relative to the injector tip, not relative to the spray. The spray itself shows some variation in position of the edge of the spray from one spray to the next, which may affect the distributions, although photographs of the spray demonstrate these variations to be small. At first, the probe position was focused to the tip of the injector nozzle. After that, the probe position was moved by adjusting the traversing tables which support the transmitter and receiver.

After setting the injection pump speed, rack position, and probe volume position, pressurized nitrogen gas was introduced into spray chamber through a regulator from a nitrogen bottle. For a specific ambient gas pressure, the pressure was read from a gage attached to the spray bomb. In order to purge residual droplets, the gas in the spray bomb flowed very slowly in through an inlet valve located on the top of the chamber and out through an outlet valve located on the bottom of the chamber. The gas velocity was found to be stagnant to 0.5 m/sec by measuring residual droplet velocity without injections. While stabilizing gas pressure, the injection pump was also run, the fuel from which was injected into the dummy tank. After the ambient gas pressure and injection system were stabilized, the fuel was switched to inject into the main spray bomb by energizing the solenoid valve. The first few injections were discarded by triggering the PDA a time later. If the optical windows were clean, the ambient gas pressure was increased to the next step and the same procedure was repeated. Otherwise, the assembly of caps and quartz windows was unbolted from the main body of the chamber and cleaned. After the windows were cleaned, the

same procedure was followed.

The sample size influences the accuracy of the measured droplet size and velocity (Hiroyasu and Kadota, 1974). The larger number of sprays sampled, the better the accuracy in transient sprays (Sangeozan, 1983). They showed 256 spray cycles provide reasonable values of droplet size. The number of samples in this research was 4,000 to 10,000 (from 30 to 500 injections) depending on the probe position and ambient gas pressure. In the PDA, the sample size was controlled by either setting the run time or the number of samples. Approaching the nozzle, the rate of sampling decreased. This was due to more multiple or non-spherical droplets in the probe volume at one sample time, which were rejected during processing of the Doppler signal. Approaching the spray axis in the radial coordinate at the same axial position, the rate of sampling also decreased. More time was required to take enough data at the spray axis in the near nozzle region than in the spray edge or downstream region. During data acquisition in the near nozzle region, the optical window would become covered with fuel and it became impossible to continue acquiring data. Near the nozzle, the sample size was controlled by the run time during which the optical windows were clean rather than number of samples, which means the number of data in each run was not enough to analyze statistically. When the data were analyzed, several runs which were taken under same conditions were combined.

The PDA has the capability to measure droplet sizes ranging approximately from $1\mu\text{m}$ to $1000\mu\text{m}$. The measurable droplet size span is determined by the specific setting of the optical parameters. The dynamic size range, which is the ratio of maximum droplet size to the smallest droplet size being detectable, is 35. An improper selection of dynamic size range in the size span may lead to an erroneous interpretation of the Doppler phase shift into droplet size. The dynamic size range should be in the middle or lower part of the selected size span. The detailed description of the selection of size span is given below.

When larger droplets pass the edges of the

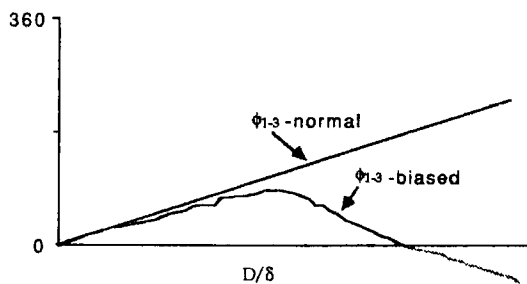

Fig. 3 Schematic of the instrument response curve for the normal and biased case

Gaussian intensity beam in the probe volume, reflection becomes the dominant component in the scattered light (Bachalo and Sankar, 1988). The reflection component in the forward scattering is undesirable. The slope of the instrument response curve shown in Fig. 3 is gradually decreases as external reflection begins to dominate internal reflection. Larger droplets are interpreted as small ones when the phase difference is biased toward the lower value. For the very large droplets, the phase difference (e.g., ϕ_{1-3}) falls to negative values. This is then recorded as a positive phase of $360 - \phi_{1-3}$. This positive phase is interpreted as a size larger than the actual size.

The erroneous interpretation of droplet size, measured phase shift, or difficulties in the measurement become severe in the dense spray (such as the diesel fuel spray when the size span was not chosen properly). A dense spray requires a smaller probe volume in order to allow one droplet to be in the probe volume at one sample time. But, larger droplets which may be found in the dense spray region require a larger probe volume in order to avoid the problems mentioned above.

The other misinterpretation of size observed in the initial tests of the diesel fuel spray is misplacement of the instrument response curve between 0 to 360 degrees cycle and 360 to 720 degrees cycle. The problem may be due to the poor signal to noise ratio (SNR) in difficult measuring environments such as dense regions of the diesel fuel spray. The misplacement of the instrument cycle curve produced a group of droplets on the upper side of the size range, which

Table 1 Droplet size measurement span for different optical parameters

Transmitter lens (mm)	Collimating lens (mm)	Beam waist diameter (μm)	Grating track	Beam separation (mm)	Fringe spacing (μm)	Nominal fringe count	Droplet size span (μm)
300	160	200	1	6.3	30.1	7	3.5-493
		200	2	12.6	15.1	13	1.8-246
		200	3	25.0	7.6	26	0.9-124
	300	107	1	11.6	16.4	7	1.9-268
		107	2	23.6	8.0	13	0.9-132
		107	3	46.8	4.1	26	0.5-66

made another peak in the size distribution in addition to the normal higher peak of the size distribution. These size distributions looked bi-modal or tri-modal with a gap between them. One way to check whether the larger groups in these multi-modal distributions are real or not is to use "intensity validation check" software.

The droplet size span was dependent upon the selection of the optical parameters as shown in Table 1. Improper selection of the size span resulted in erroneous size interpretation from the Doppler phase shift. The strategy used for the selection of size span in this experiment in order to avoid the problems mentioned above was to set the upper value of size approximately twice the estimated largest droplet.

3. Sensitivity of the PDA to Dense Droplet Laden Jet

In order to produce a valid measurement of drop size using the PDA, the following criteria must be met :

- (a) the droplet must be nearly spherical
- (b) with a counter processor, at most, one droplet is allowed to pass through the probe volume during the measurement time
- (c) the droplet size and velocity must be within the range of the instrument at the particular filter and optical settings being used to obtain the measurement.

Dense fuel sprays, such as the ones studied in this research, have regions in the spray where these criteria are frequently not met. This results in a significant question regarding the validity of

data obtained in dense sprays. Before discussing this problem, consistency checks were performed as described below.

3.1 Consistency of PDA for the measurement of droplet size and velocity

The PDA has been demonstrated to accurately provide fundamental data in relatively non-dense sprays. The PDA was also tested in a stream of monodisperse drops which was produced using a vibrating orifice drop generator. Figure 4(a) represents histograms of size and velocity of the liquid jet from a $67.5 \mu\text{m}$ diameter orifice with a driving frequency of 31 kHz, where 100 percent validation rates were achieved with a unique, almost single-valued droplet size. The measurement position of Fig. 4(a) was 15 mm from nozzle. The measured drop size and velocity was $116.7 \mu\text{m}$ and 9.98 m/s. The estimated drop size from the Rayleigh instability based on optimum driving frequency (32.7 kHz) was $128 \mu\text{m}$ and the velocity from the known flow rate and orifice size was 9.97 m/s. The discrepancy between the PDA measurement and calculation was due to off-optimum driving frequency or inaccurate orifice size measurement. At approximately 3 mm downstream of orifice, no data was obtained. This means that the jet maintained a liquid column without breakup into drops, thus no Doppler signal was produced. Only an intensity variation in the oscilloscope was observed at the same frequency as the driving frequency for the piezoelectric crystal. The lack of a Doppler signal found in a liquid column may confirm the idea that data missing from the near nozzle region in a

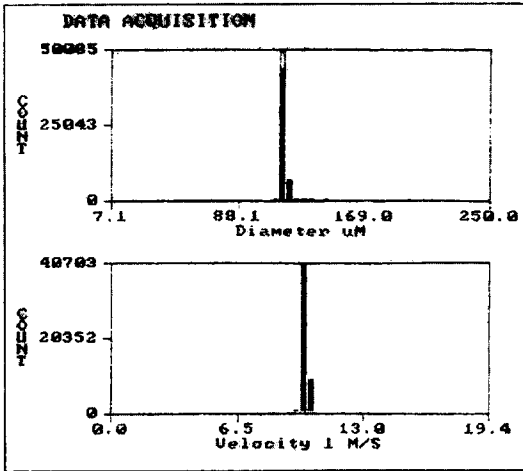

(a) Driving frequency : 31 kHz

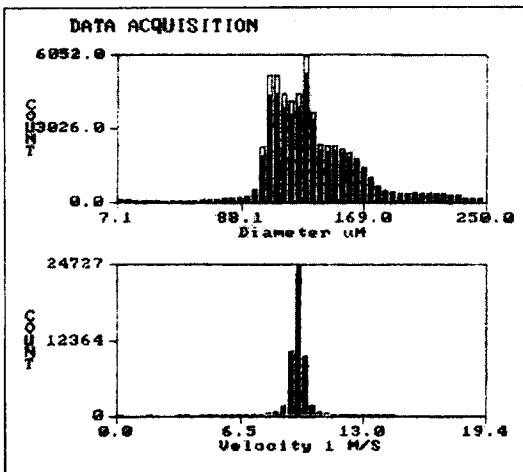

(b) No forced vibration

Fig. 4 Droplet size and velocity histograms from a stream of monodisperse drops produced by a vibrating orifice drop generator

fuel spray might be related to the unbroken liquid core or column. Figure 4(b) shows histograms of size and velocity from the same jet, conditions, and measurement position as Fig. 4(a) except that the forced vibration of the liquid jet was removed, where polydisperse drop sizes and velocities were observed.

3.2 Application of PDA to dense droplet laden jet

Dense droplet laden-jet such as dense spray, such as the ones investigated here, require much

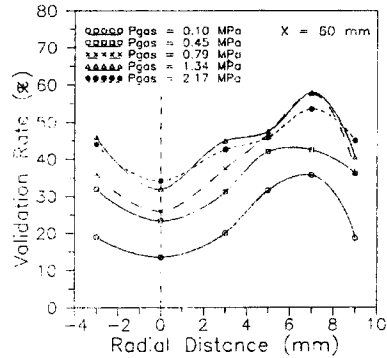

Fig. 5 Validation rate for different radial positions and ambient gas pressure

care in the use of the instrument. Because of practical limitations of the instrument and the complex nature and density of these sprays, it is unlikely that accurate measurement of flux quantities can be accomplished. Figure 5 shows the validation rate, defined to be the ratio of the number of valid measurements to the total number of measurement attempts, as a function of radial position in the spray and gas-to-liquid density ratio. As can be seen from figure, in the core of the fuel spray, very low validation rates were achieved, indicating that a majority of the mass that traversed the probe volume violated the acceptance criteria for one or more reasons. Thus it is possible that droplets that do produce valid measurements represent a subset of the data that is not representative of the actual spray behavior. Such a result could generate a misleading picture of the true spray characteristics. As ambient gas pressure was increased or probe volume position was moved to the edge of the spray, high validation rates were achieved. However, the decrease of validation rates at 9 mm (corresponding to the extreme edge of the spray) was due to an increase of the PMT voltage. The increase of PMT voltage allows more chance for background noise to be included in the signal. Note that validation rates were sensitive to the probe volume position, ambient gas density, and the PMT voltage.

The data reported in this paper represent the results of many variations in instrument operation, such as PMT voltage, frequency shift, and optical configuration. In order to ensure that the

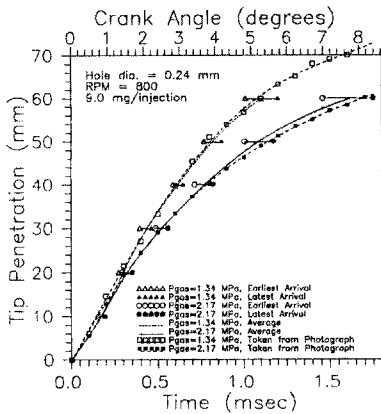

Fig. 6 Tip penetration for different ambient gas pressures, determined from high-speed photographs, and measured velocity data

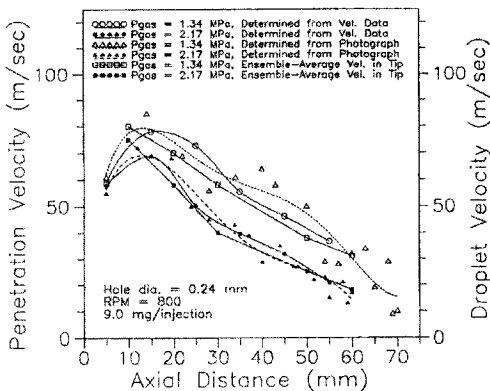

Fig. 7 Penetration velocity and droplet velocity at the spray tip for different ambient gas pressure, determined from high-speed photograph, and the measured velocity data

results were repeatable, consistent, and physically realistic, several different tests and comparisons were performed.

For example, comparisons of tip penetration and tip velocity, as determined from high-speed photography, with measurements of the tip velocity from the PDA showed very similar results. This is illustrated in Figs. 6 and 7. Details such as the phase and magnitude of the change in slope in the penetration data are observed to be nearly identical for the two techniques.

Comparison of velocity-only measurements with velocity measurements in which velocity and diameter were obtained is pictured in Fig. 8. In

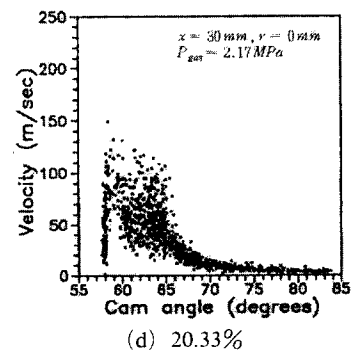
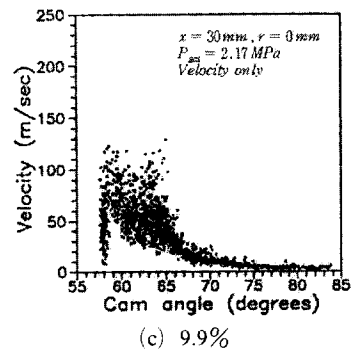
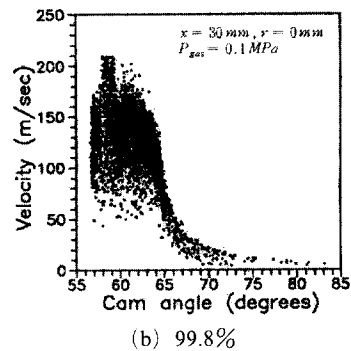
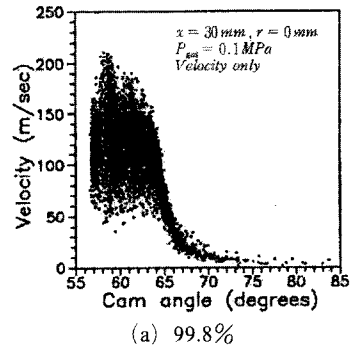

Fig. 8 Comparison of velocity only and velocity data obtained when both velocity and diameter data were acquired. Measurement position and condition: $x=30$ mm, $r=0$ mm, $P_{gas}=0.1$ MPa and 2.17 MPa

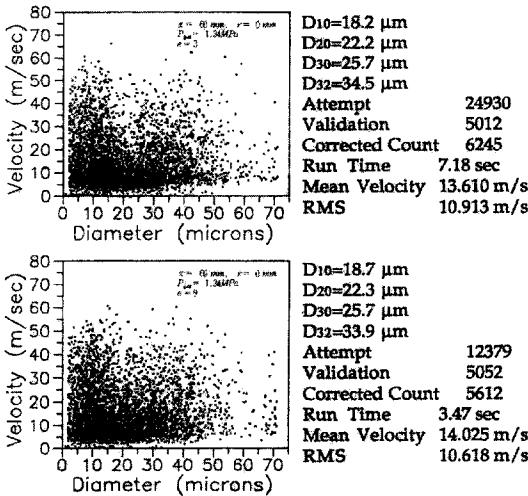

Fig. 9 Effect of droplet sphericity criteria on data characteristics. Measurement position and condition : $x=60$ mm $r=0$ mm $P_{gas}=1.34$ MPa

this case, the PDA was used for both sets of measurements. For the former it was used as a conventional LDV to measure velocity only. When the PDA was used as an LDV in the transient spray, validation rates were nearly 100 percent, even in the core of the spray. When velocity and size were measured simultaneously, the validation ratio near the nozzle tip was as small as 10 to 20% due to non-spherical droplets or multiple droplets in the measurement volume. Of course, the run time to take the same number of data was much longer for the simultaneous measurement of sizes and velocities. As is illustrated in the figure, the characteristics of the two data sets are seen to be the same. If the subset that was used to produce the size/velocity information had different characteristics than the actual ensemble, it would be expected to see different characteristics here.

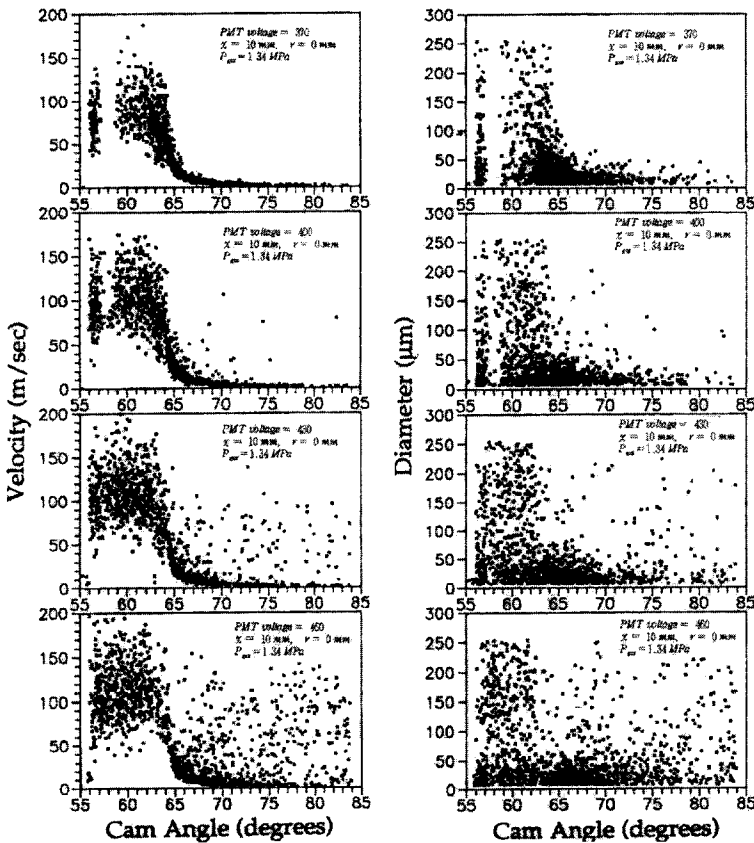

Fig. 10 Effect of PMT voltage on data characteristics. Measurement position and condition : $x=10$ mm $r=0$ mm $P_{gas}=1.34$ MPa

Next, internal instrument settings were varied to observe the effects on the results. For example, for each droplet, the size is measured by two different pairs of PMT's, each pair viewing a different portion of the spatial fringe pattern generated when a droplet passes through the measurement volume. If the size determined from each of the pairs of PMT's differs by more than a selected amount, than that droplet is considered to be non-spherical and that data invalid. The possibility of each detector observing different portion of droplet is increased in dense droplet with non-sphericity. For example, Fig. 9 compares the drop size and velocity data obtained for two different settings for the size comparison, $\epsilon=3\%$ and $\epsilon=9\%$. ϵ is the sphericity ratio between detectors 1-2 and 1-3. Again, little difference is observed in the data. Note that these two data sets had much different validation rates.

Effects of PMT voltage were considered. In a dense spray with a large range in droplet size, setting of the PMT voltage can greatly influence the size distribution obtained, as exhibited in Fig. 10 and Fig. 11. This procedure has been to establish a range of PMT voltage where the size distribution is insensitive to PMT voltage setting. This range is dependent on the position in the spray, and should be determined each time the measurement position is changed. A low PMT voltage prevents the detectors from detecting scattered light from the droplets in the middle of the injection event, however, noise dominates after the end of injection for the elevated ambient gas pressures. The velocities produced by the noise were easily recognized because these droplets have velocities of 20 m/sec or higher after

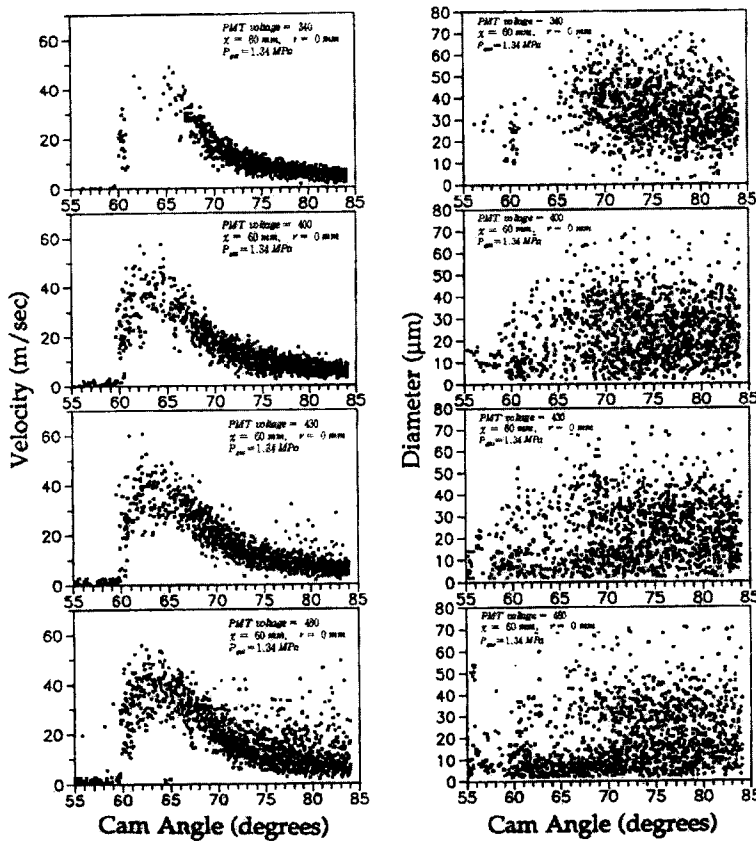

Fig. 11 Effect of PMT voltage on data characteristics. Measurement position and condition : $x=60$ mm $r=0$ mm $P_{gas}=1.34$ MPa

the injection event. Before taking data, optimum PMT voltage ranges were surveyed through a preliminary test of several ranges of the PMT voltage. The strategy to determine the proper

PMT voltage, for example, 370 volts for the case of Fig. 10 and 400 volts for Fig. 11, was to produce ranges so that data in the middle of the spray event should appear and the after injection

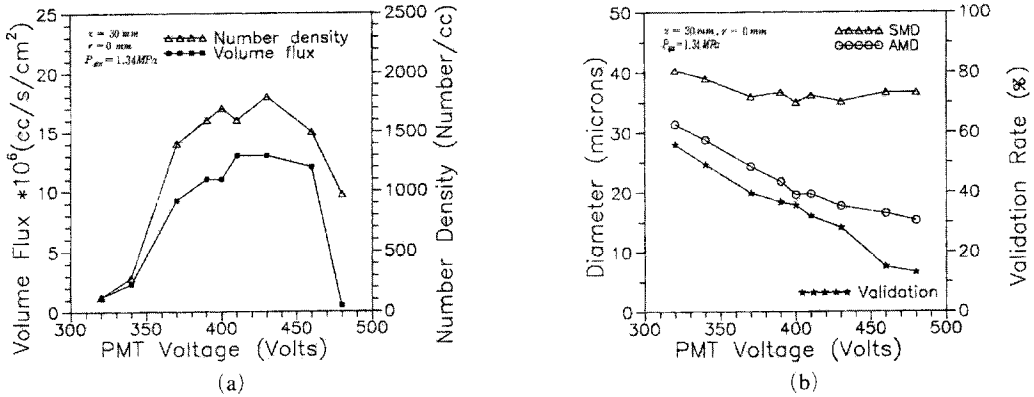

Fig. 12 Effect of PMT voltage on the spray-ensemble data : (a) Volumeflux and number density (b) Droplet size and validation rate. Measurement position and condition : $x=60$ mm $r=0$ mm $P_{gas}=1.34$ MPa

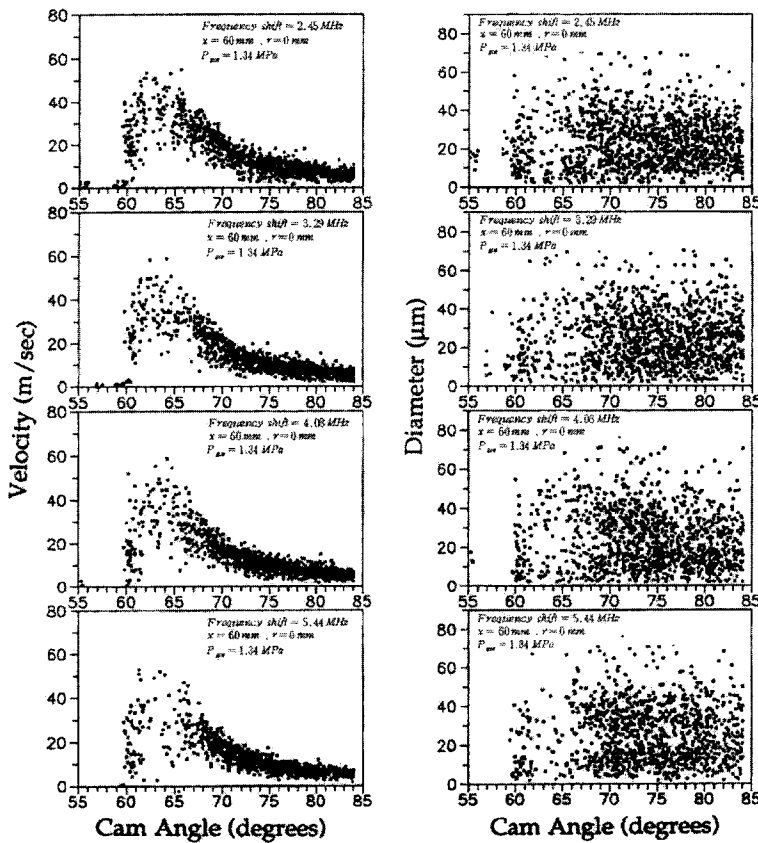

Fig. 13 Effect of shift frequency on velocity and diameter. Measurement position and condition : $x=60$ mm $r=0$ mm $P_{gas}=1.34$ MPa

event should not have noise from the transient velocity data.

Figure 12(a) and (b) show the trend of the volume flux, number density, diameters, and validation rate versus PMT voltage for the spray ensemble. Even though the absolute value of these quantities are not correct, this plot provides another criteria for the proper selection of the PMT voltage. The criterion for the optimum PMT voltage was that data such as volume flux and diameters do not change rapidly. Recently the manufacturer offered a new method to select PMT voltage automatically. In this case, the appropriate PMT voltage can be determined from the statistical treatment of the measured signal amplitude along with the signal period and phase for a few iterations of the preset number of measurements. In a transient fuel spray, however, it was very difficult to find a appropriate PMT voltage because the signal amplitude was changing so dramatically with time, especially between the injection and no injection periods.

Finally, the effect of frequency shift on the measurement of droplet sizes and velocities is shown in Fig 13. The accuracy of phase measurement is influenced by the accuracy of the Doppler frequency. The upper frequency which can be measured by the counter is lower than certain criterion, e.g., 6 MHz in order to limit the error of the measured Doppler frequency to less than 1% (Hardalupas, 1989). The shift frequency should be chosen such that the moving fringe velocity is twice the maximum flow velocity (Dust et al., 1981). The effect of frequency shift in Fig. 13 was relatively minor in the range of the shift frequency less than 6 MHz, but there was an optimum frequency shift for the given spray conditions and optical configuration (e.g., 3.29 MHz in Fig. 13).

To conclude this discussion, there is no direct verification that the drop-size distributions obtained are, in fact, the same as the actual size distributions in the spray. It is possible that the results may not represent the ensemble actually occurring in the spray, although the consistency achieved in the results measured over a wide range of instrument settings makes this unlikely.

The aforementioned results tend to support the hypothesis that these results are similar, however. In the results to be presented, the assumption has made that the results obtained are typical of the actual spray characteristics and hence statistical quantities, such as the Sauter Mean Diameter (D_{32}), are very likely representative of the spray. Note that flux measurements were not reported because of the large amount of mass passing the measurement volume that would not be included in a flux calculation.

4. Conclusions

In order to ensure that the results from the drop size and velocity measurements were repeatable, consistent, and physically realistic, several different assessments and comparisons were performed.

(1) Comparisons of tip penetration and tip velocity, as determined from high-speed photography, with measurements of tip velocity from the PDA showed very similar results. Details such as the phase and magnitude of the change in slope in the penetration data are observed to be nearly identical for the two techniques.

(2) Comparison of velocity-only measurements with velocity measurements in which velocity and diameter were obtained showed no difference.

(3) The effect of PMT voltage on data characteristics were investigated. The strategy adopted to determine the proper PMT voltage is to produce ranges such that data in the middle of the spray event should appear and the after injection event should not have noise from the transient velocity data.

(4) The effect of shift frequency was found to be minor if the shift frequency is less than certain criterion, e.g., 6 MHz.

References

- Bachalo, W. D. and Sankar, S. V., July 1988, "Analysis of the Light Scattering Interferometry for Spheres Larger than the Light Wavelength," *Fourth International Symposium on Application of Laser Anemometry to Fluid Mechanics, Lisbon.*

- Borman, G. L., 1985, "Reciprocating Engine Combustion Research Needs," SAE paper No. 850398.
- Borman, G. L. and Ragland, K. W., 1998, *Combustion Engineering*, McGraw-Hill.
- Dodge, L. G., Rhodes, D. J. and Reitz, R., 1987, "Drop-size Measurement Techniques for Sprays: Comparison of Malvern Laser-Diffraction and Aerometrics Phase/Doppler," *Applied Optics*, 26 (11).
- Durst, F. and Zare, December 1975, "Laser Doppler Measurements in Two-Phase Flows," *Proc. LDA Symposium, Copenhagen*, pp. 403~429.
- Durst, F., Melling, A. and White J. H., 1981, *Principles and Practice of Laser Doppler Anemometry*, Academic Press.
- Hardalupas, I., 1989, Experiments with Isothermal Two Phase Flow, Ph. D Thesis, Imperial College of Science, Technology. and Medicine.
- Heywood, J. B., 1988, *Internal Combustion Engine Fundamentals*, McGraw-Hill.
- Hiroyasu, H. and Kadota, T., 1974, "Fuel Droplet Size Distribution in Diesel Combustion Chamber," SAE paper 740715.
- Jackson, A. A. and Samuelson, G. S., 1987, "Droplet Sizing Interferometry: A Comparison of the Visibility and Phase/Doppler Techniques," *Applied Optics*, 26(11).
- Piltcher, G., Wigley, G. and Saffman, M., 1990, "Velocity and Drop Size Measurements in Fuel Sprays in a Direct Injection Diesel Engine," *Part. Part. Charact.*, Vol. 7, pp. 160~168.
- Sangeorzan, B. P., 1983, "Time-Resolved Measurements of Drop Size Distribution in a Transient Fuel Spray," Ph. D. Thesis, University of Wisconsin-Madison.
- Switzer, G. L. and Jackson, T. A., 1988, "Investigation of Velocity and Turbulence Intensity Measurement Limitations of the Phase Doppler Particle Analyzer," *1988 Spring Technical Meeting, Central States Section*, The Combustion Institute, May 2-3.
- Yule, A. J. and Aval, S. M., 1989, "A Technique for Velocity Measurements in Diesel Sprays," *Combustion and Flame*, Vol. 77, pp. 385~394.
- Yule, A. J., Mo, S. L., Tham, S. Y. and Aval, S. M., 1985, "Diesel Spray Structure," *ICLASS-85*, London.